

Introduction

The Dynapar brand MSjr4 Digital Speed Controls provides premium performance and application flexibility in a compact, economical and easy-to-use package.

The MSjr4 operates as a leader or follower. In the leader mode, the speed display and setpoints are calibrated to engineering units (RPM, feet/min, liters/hour) for operator convenience. The actual and setpoint units can also be inversely proportional to speed, for applications that need to control process time in minutes and seconds. The follower mode will precisely match the speed of one motor, machine section or manufacturing process to another, with the assurance of zero cumulative error (drift) over time.

The MSjr4 uses true Proportional/Integral/Derivative control for increased performance and stability, with Velocity Feedforward to provide quick response with lower loop gain. The unique Setup displays allow quick setting of loop gains. Full programmability is provided for input range, accel/decel ramp rate, display calibration, alarms, and operator access. Programmed settings are retained in nonvolatile memory during the absence of power.

Installation is simplified through the use of pluggable terminals and simple input and output diagnostics. The rugged metal enclosure and isolated drive output provide complete immunity from electrical noise. The universal power input is fully filtered for low emissions.



Features

- Leader or follower operation
- Leader operation in speed or process time units
- Full Proportional, Integral, Derivative loop control with Velocity Feedforward
- Zero cumulative error (drift) in follower mode
- Speed, Ratio, Process Time and Jog setpoints
- High and low speed alarm outputs
- Easy PID setup and built-in diagnostics
- Multiple level security: Setpoints, PID gains, Program data
- Isolated analog output to drive control
- Selectable 5V or 12V sensor power
- Magnetic, TTL or square wave inputs
- Large, bright LED display
- NEMA 4 / IP65 panel seal with gasket
- Nonvolatile RAM provides 10+ years data and program retention

Index

Overview	
Construction	page 2
Specifications	page 3
Installation	
Configuration Switches	page 4
Panel Mounting	page 5
Wiring	page 5-7
Programming	
Front Panel Operation	page 8
Operating Displays	page 9
Setup Displays	page 10
Program Displays	page 11-13
Diagnostics	page 14
Error Codes	page 15
Operation	
Speed Control	page 16
Process Time	page 17
Speed Follower	page 17
Application Hints	page 18
PID Tuning	page 19
General	
Ordering Information	page 20
Warranty	page 20
Service	page 20

**Technical Manual
#701906-0001**

**Dynapar brand
MSjr4
Digital Speed
Control**

OVERVIEW

CONSTRUCTION



Compact Design

True 1/8 DIN bezel
Smaller than competitive units

Large LED Display

Display Speed, Ratio or Process Time setpoints
Calibrated speed display (tachometer)
Programmable decimal points, colon

Programming and Status Indicators

Identifies display values
English programming prompts

Simple Keypad Programming

Completely menu driven programming
Interactive setup of calibration and loop gains
Built-in I/O diagnostics

Front Panel Seal

NEMA 4 / IP65 rated when installed with panel mount gasket (supplied)

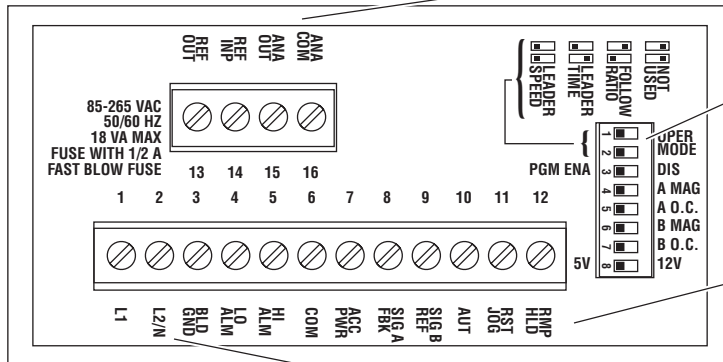

Isolated Analog Output

Complete electrical isolation from drive
Internal or external (drive supplied) reference

Switch Selectable Operation

Leader Speed/Time or Follower modes
Program disable for security
Magnetic, TTL or squarewave inputs
Selectable 5V or 12V sensor supply

Control Inputs and Outputs

Auto or Manual operation
Open loop or closed loop
Manual Jog
Ramp inhibit (hold speed)

Universal Power Input

85 to 265 VAC for worldwide operation
Filtered for low emissions/high immunity

Rugged Aluminum Enclosure

Superior mounting without fatigue
Shielding for maximum noise immunity

SPECIFICATIONS

Input Power

Terminals 1 (HOT/L1) and 2 (NEU/L2)
85 to 265 VAC, 50/60 Hz, 18 VA max.;
external 1/2 A. "fast blow" type fuse required

Sensor Power

Terminal 7 (ACC PWR) and 6 (COM)
Selectable: +5 VDC \pm 10% when switch #8 is left; +12 VDC \pm 10% when switch #8 is right; 0 to 125 mA max.

Signal Inputs

Terminal 8 (SIGA FBK): Feedback sensor for closed loop operation
Terminal 9 (SIGB REF): Reference sensor for speed follower operation
Input Voltage, High: 3.5 min. to 30 VDC max.; 0.3 min. when switch #4 (A MAG) or switch #6 (B MAG) is right
Input Voltage, Low: 0 min. to 1.5 VDC max.; -0.3 min. to -30 max. when switch #4 (A MAG) or switch #6 (B MAG) is right
Input Impedance: 10 k Ω to COM; optional 3.3 k Ω to +5 VDC when switch #5 (A O.C.) or switch #7 (B O.C.) is right
Input Response: 0 Hz to 20 kHz each; 25 μ sec. min. high or low; 20 Hz min Reference

Setpoints

Speed: 4 digit, programmable decimal point
Ratio: 4 digit, fixed decimal point X.XXX
Process Time: 4 digit, fixed format XX:XX minutes and seconds
Jog: 4 digit

Alarms:

Number: 2, individual high and low alarm setpoints
Type: programmable in setpoint units or percentage of setpoint
Operation: Active when actual speed, ratio or process time is less than low alarm, greater than hi alarm

Control Inputs

Terminal 10 (AUT): Auto when low, Manual when open or high; closure initiates accel to setpoint when stopped, opening initiates decel to stop when running; must be open or high (and stopped) to access Program displays
Terminal 11 (JOG-RST): Manual (AUT input open): Jogging when low, stopped when high or open; Auto (AUT input closed): Error Reset (open loop operation) and Alarms disabled when low, Error Active (closed loop operation) and Alarms enabled when open or high

Terminal 12 (RMP HLD): Ramping disabled when low, enabled when open or high
Input Voltage, High: 3.5 min. to 30 VDC max.
Input Voltage, Low: 0 min. to 1.5 VDC max.
Input Impedance: 2.2 k Ω to +5 VDC
Input Response: 25 msec. min.

Display

Type: High efficiency red, 7 segment LEDs
Height: 0.56" (14 mm)
Number: 5 digits; 9 annunciators
Decimal Point/Colon: XXXX (none) to X.XXX; or XX:XX

Front Panel Keys

Number: 6 (Down, Right, +, -, Program, Reset)
Type: Tactile response

Security

Setpoint Data: Adjustable incrementally, digit by digit, both or none
Setup Data: Accessible only when Setup is On
Program Data: Accessible only when switch #3 is left

Analog Output

Terminal 15 (ANA OUT)
Range: 0 to 10 VDC at 5 mA max. when using internal reference; 0 to external Reference, 15VDC max.
Resolution: 10 mv, 0.1% of full scale
Isolation: 1000 VAC/VDC min.

Control Outputs

Terminal 4 (LO ALM)
Terminal 5 (HI ALM)
Type: NPN open collector, sink to COM
Output High: 30 VDC max., 100 μ A. max. leakage current
Output Low: 1 VDC max., 100 mA. max.

Mechanical

Enclosure Dimensions: 1.67" (42mm) H x 3.54" (90mm) W x 6.1" (156mm) L
Bezel Dimensions: 1.9" (48mm) H x 3.8" (96mm) W x 0.35" (9mm) D
Panel Cutout Size: 1.78" H x 3.58" W (45 H x 92 W mm)
Panel Thickness: 1/16" (1.6mm) to 1/4" (6mm)
Depth Behind Panel: 5.75" (147mm)

Environmental

Operating Temp.: 32 to 122 $^{\circ}$ F. (0 to 50 $^{\circ}$ C.)
Storage Temp.: 0 to 186 $^{\circ}$ F. (-18 to 85 $^{\circ}$ C.)
Ambient Humidity: 0 to 90% noncondensing
Front Panel Seal: NEMA 4 / IP65 when installed with panel gasket (supplied)

INSTALLATION

CONFIGURATION SWITCHES

NOTE:
Switches #1 and #2 are used, in combination, to set the mode of operation.

NOTE:
Switches #1 and #2 in the right position are not used on MSjr4.

	LEFT	RIGHT
1	Leader Mode Selects stand-alone for control of speed or process time, as selected by switch #2 directly below.	Follower Mode Selects multiple unit operation for speed follower.
2	Leader Speed / Follower Ratio Selects Speed setpoint operation for leader mode, or Ratio setpoint operation for follower mode.	Leader Time Selects Process Time setpoint for leader operation. Do not use this position in Follower mode, when switch #1 is right.
3	Program Enable Allows access to Program data when the PGM key is pressed (unit must be stopped prior to programming).	Program Disable Access to Program data is not allowed when PGM key is pressed.
4	Signal A Squarewave Threshold Selects nonzero voltage thresholds, suitable for squarewave (sinking/sourcing) output devices.	Signal A Magnetic Threshold Selects zero-crossing voltage thresholds, suitable for sinewave (variable reluctance) output devices.
5	Signal A Current Source Selects input pull-down resistor, suitable for use with current sourcing output devices.	Signal A Open Collector Selects input pull-up resistor, suitable for use with open collector or current sinking output devices.
6	Signal B Squarewave Threshold Selects nonzero voltage thresholds, suitable for squarewave (sinking/sourcing) output devices.	Signal B Magnetic Threshold Selects zero-crossing voltage thresholds, suitable for sinewave (variable reluctance) output devices.
7	Signal B Current Source Selects input pull-down resistor, suitable for use with current sourcing output devices.	Signal B Open Collector Selects input pull-up resistor, suitable for use with open collector or current sinking output devices.
8	5V Accessory Power Selects +5 VDC output for terminal 7 (ACC PWR), for use with TTL and 5V CMOS devices.	12V Accessory Power Selects +12 VDC output for terminal 7 (ACC PWR), for use with non-TTL devices.

Record your Configuration Switch settings in the chart below for future reference.

1		
2		
3		
4		
5		
6		
7		
8		

PANEL MOUNTING

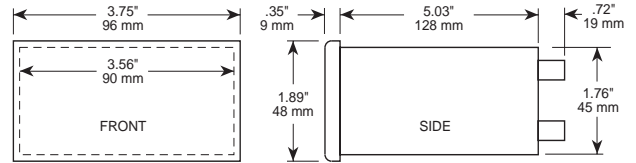

CAUTION:

Avoid cleaning agents which contain ammonia! Repeated contact with ammonia may weaken the plastic. Many lubricants are not compatible with the structural plastic of the bezel. Repeated exposure to these lubricants may weaken the plastic.

Panel Mounting

Make panel cutout(s) according to the details in the drawing at right.

If the installation requires a front panel seal, apply the adhesive gasket (supplied) to the outside of the panel.

Remove the hex washer head screws from the rear of the unit and slide the panel mount straps out of their guides. Slide the unit backward through the cutout and insert the straps back into the guides.

Tighten the screws to secure the unit to the panel.

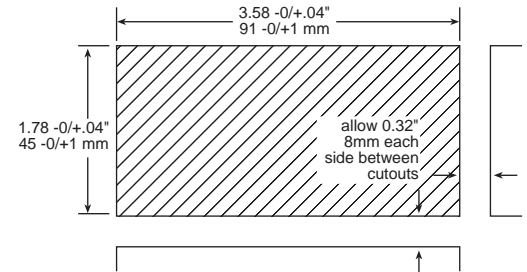

WIRING

WARNING!

In installation and use of this product, comply with the national electrical code; federal, state and local codes, and any other applicable safety codes. In addition, turn off power and take other necessary precautions during installation, service and repair to prevent personal injury, property loss and equipment damage.

AC Power Input

Connect AC power to L1/HOT (terminal 1) through a 1/2 A., "fast blow" type fuse and to L2/NEU (terminal 2), as shown in the diagram on the right. Connect Earth Ground to BLD GND (terminal 3). AC power should be from a separate branch circuit that is noise-free and does not feed heavy loads.

IMPORTANT: In severe electrical noise environments, shielded cable for signal inputs and outputs is recommended. Connect the shield only to terminal 3 (BLD GND).

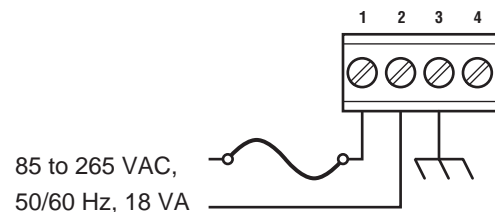

WIRING

Solid State Outputs

To drive DC relays, such as the PM31, connect LO ALM (terminal 4) or HI ALM (terminal 5) and ACC PWR (terminal 7) as shown at right, bottom. Since the PM31 requires 12VDC power, set switch #8 right.

If ACC PWR is set for 5VDC sensors, or cannot provide enough current to power the relays, use a PM41S power supply. Connect LO ALM (terminal 4) or HI ALM (terminal 5) and COM (terminal 6) as shown at right, top.

PM41S Power Supply

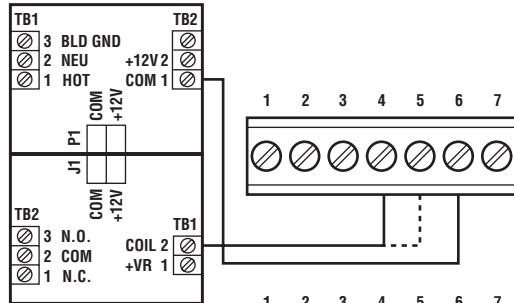

PM31 Relay Module

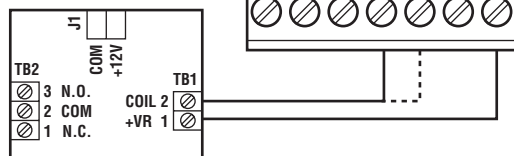

PM31 Relay Module

NOTE:

When using current sourcing devices, set switches #4-7 left.

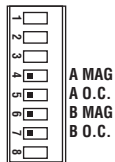

Current Sourcing Sensor Inputs

Set switches as shown on the left independently for SIGA (FBK) and SIGB (REF).

Set the Accessory Power switch #8 for 5V or 12V as required by the sensor(s).

Connect the Feedback device signal to SIGA FBK (terminal 8). For Follower operation, connect the Reference device signal to SIGB REF (terminal 9).

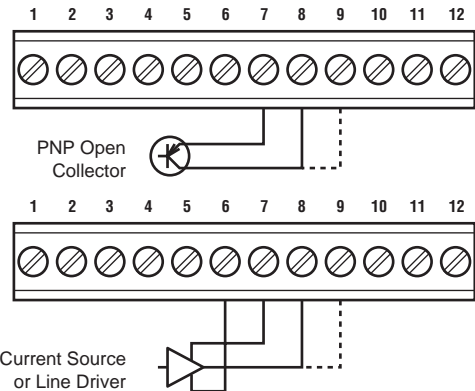

NOTE:

When using current sinking devices, set switches #4 and #6 left and switches #5 and #7 right.

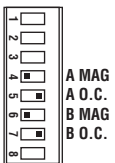

Current Sinking Sensor Inputs

Set switches as shown on the left independently for SIGA (FBK) and SIGB (REF).

Set the Accessory Power switch for 5V or 12V as required by the sensor(s).

Connect the Feedback device signal to SIGA FBK (terminal 8). For Follower operation, connect the Reference device signal to SIGB REF (terminal 9).

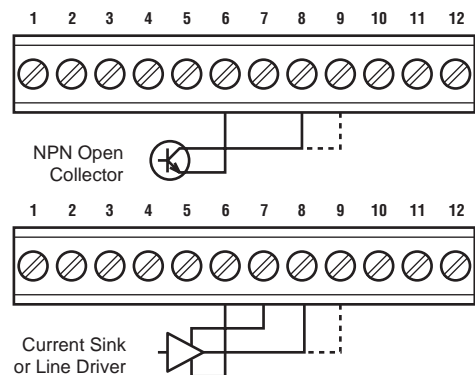

NOTE:

When using magnetic (sine wave) devices, set switches #4 and #6 right and switches #5 and #7 left.

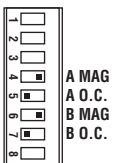

Magnetic Sensor Inputs

Set switches as shown on the left independently for SIGA (FBK) and SIGB (REF).

Connect the Feedback device signal to SIGA FBK (terminal 8). For Follower operation, connect the Reference device signal to SIGB REF (terminal 9).

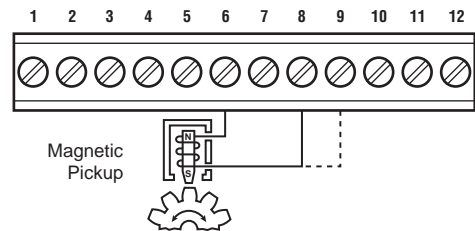

WARNING!

When the unit is used to control a machine or process where personal injury or equipment damage might occur as a result of failure of any electronic or other controller function, you are urgently recommended to insist on installation of safeguards which would protect the operator and/or machine in the event of any unexpected operation of the machine or process.

Control Inputs

Connect the Jog pushbutton switch (if used) to RST-JOG (terminal 11) and COM (terminal 6).

Connect a Manual/Automatic toggle switch to AUT (terminal 10) and COM (terminal 6).

Connect an Open Loop toggle switch (if used) to RST-JOG (terminal 11) and COM (terminal 6).

Connect a Ramp Hold toggle switch (if used) to RMP HLD (terminal 12) and COM (terminal 6).

To enable Jog during Manual operation and Open Loop during Automatic operation, connect those switches in series with the Auto/Manual switch, as shown at right.

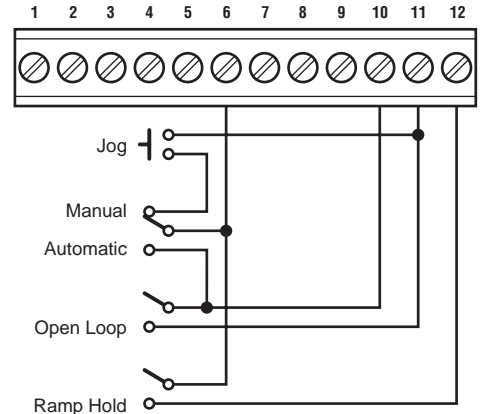

Analog Output

To use the internal reference to provide a 0-10V command output, connect REF OUT (terminal 13) to REF INP (terminal 14). Connect ANA OUT (terminal 15) and ANA COM (terminal 16) to the drive input as shown at upper right.

To use the drive's reference and have the command output limited to the drive's input range, connect the +V, Wiper and Com of the drive to the REF INP (terminal 14), ANA OUT (terminal 15) and ANA COM (terminal 16), respectively, as shown at lower right.

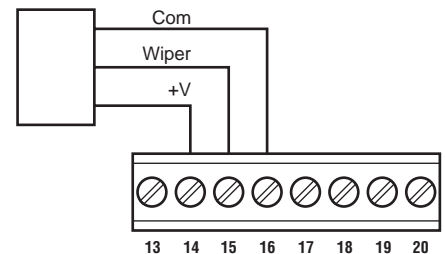
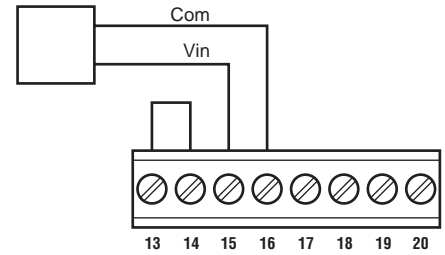

FRONT PANEL OPERATION



 The Down cursor is used to scroll the operator and setup displays and the programming menu. When the last item is being displayed, the Down cursor will "wrap around" to the top display.

 The Right cursor key selects one digit of data to be changed when editing numeric data. The first keypress will select the leftmost digit; additional presses will select digits further to the right. The chosen digit will appear brighter than the rest of the digits. That digit may then be changed with the + and - keys.

The Right cursor also selects the multiple choice programming data, scrolling through the available choices, with "wrap around".

 The + key will change the selected (brighter) digit of Setpoint, Setup or Program Data by adding 1 to it. Rollover occurs from 9 back to 0. Holding the + key will cause the digit to change repeatedly about twice per second.

If no digit is selected, the + key will increase the data by 1, with carries to the higher digits.

Prompts

Annunciators are used to indicate which Setpoint, Setup or Programming Data is displayed:

SPD	Speed value (actual, setpoint, etc.)
RAT	Ratio setpoint
TIM	Process Time (actual, setpoint, etc.)
SET	Setpoint value
MAX	Maximum value
MIN	Minimum value
REF	Reference (sensor or analog inputs)
FBK	Feedback (sensor input)
JOG	Jog setpoint value

The **MAX** and **MIN** annunciators also indicate the high and low alarm status during operation.

 The - key will change the selected (brighter) digit of Setpoint, Setup or Program Data by subtracting 1 from it. Rollover occurs from 0 to 9. Holding the - key will cause the digit to change repeatedly about twice per second.

If no digit is selected, the + key will decrease the data by 1, with borrows from the higher digits.

 The Program key will access Program data displays if the switch #3 is left (Program Enabled), and the unit has been stopped. Pressing the Program key again will return to Operator display.

Pressing the Program key when switch #3 is right, or while the unit is running, will have no effect.

 The Reset key can be used to zero the values of Program data before entering numeric data.

The Reset key is also used to clear Error Codes that are displayed when the unit is running.

NOTE:

Selected (brighter) digits are shown in this manual in **BOLD**:

123.456

OPERATING DISPLAYS

The Operating displays, are accessible when the unit is not being programmed.

The displays depend on the settings of switches #1 and #2, OPER MODE, as shown below:

Actual Speed and Speed Setpoint displays are available in the Leader Speed mode (switch #1 and #2 left).

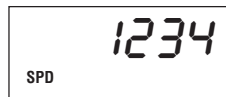

1. Actual Speed

The actual speed is displayed in engineering units and calculated from:

$$\text{Maximum Speed} \times \frac{\text{feedback input freq}}{\text{Maximum Feedback Freq}}$$

and has the same decimal point position as Maximum Speed.

2. Speed Setpoint

The Speed Setpoint is displayed in engineering units with the same decimal point position as Maximum Speed. It can be changed incrementally, digit-by-digit, both ways or not at all, as programmed by Setpoint Adjust Method. It cannot be changed higher than Maximum Setpoint or lower than Minimum Setpoint.

Actual Process Time and Process Time Setpoint displays are available in the Leader Time mode (switch #1 left and #2 right).

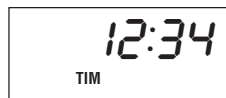

1. Actual Process Time

The actual time is displayed in minutes and seconds and calculated from:

$$\text{Minimum Time} \times \frac{\text{Maximum Feedback Freq}}{\text{feedback input freq}}$$

2. Process Time Setpoint

The Process Time Setpoint is displayed in minutes and seconds. It can be changed incrementally, digit-by-digit, both ways or not at all, as programmed by Setpoint Adjust Method. It cannot be changed higher than Maximum Setpoint or lower than Minimum Setpoint.

Actual Speed and Ratio Setpoint displays are available in Follower mode (switch #1 right).

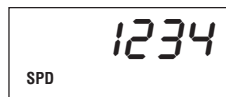

1. Actual Speed

The actual speed is displayed in engineering units and calculated from:

$$\text{Maximum Speed} \times \frac{\text{feedback input freq}}{\text{Maximum Feedback Freq}}$$

and has the same decimal point position as Maximum Speed.

2. Ratio Setpoint

The Ratio Setpoint can be changed incrementally, digit-by-digit, both ways or not at all, as programmed by Setpoint Adjust Method. It cannot be changed higher than Maximum Setpoint or lower than Minimum Setpoint.

SETUP DISPLAYS

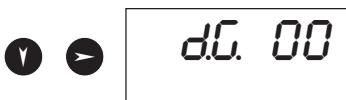
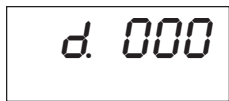
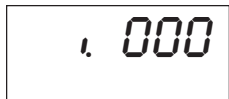
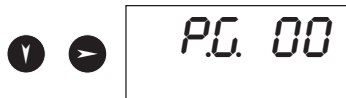

The Setup displays, are accessible when the unit is not being programmed and Setup is "On".

From the Operating displays, press the Down cursor to access the Setup displays.

3. Proportional Error / Gain

The Proportional Error displays the cumulative difference, in pulses, between the internal reference (in Leader mode) or external reference input (in Follower mode) and the feedback device.

The Proportional Gain is accessed by pressing the Right cursor. The two digits can be adjusted up or down. Pressing the Right cursor returns to the Proportional Error display.

4. Integral Error / Gain

The Integral Error displays the accumulation of the Proportional Error.

The Integral Gain is accessed by pressing the Right cursor. The two digits can be adjusted up or down. Pressing the Right cursor returns to the Integral Error display.

5. Derivative Error / Gain

The Derivative Error displays the difference in Proportional Error between successive loops.

The Derivative Gain is accessed by pressing the Right cursor. The two digits can be adjusted up or down. Pressing the Right cursor returns to the Derivative Error display.

PROGRAM DISPLAYS

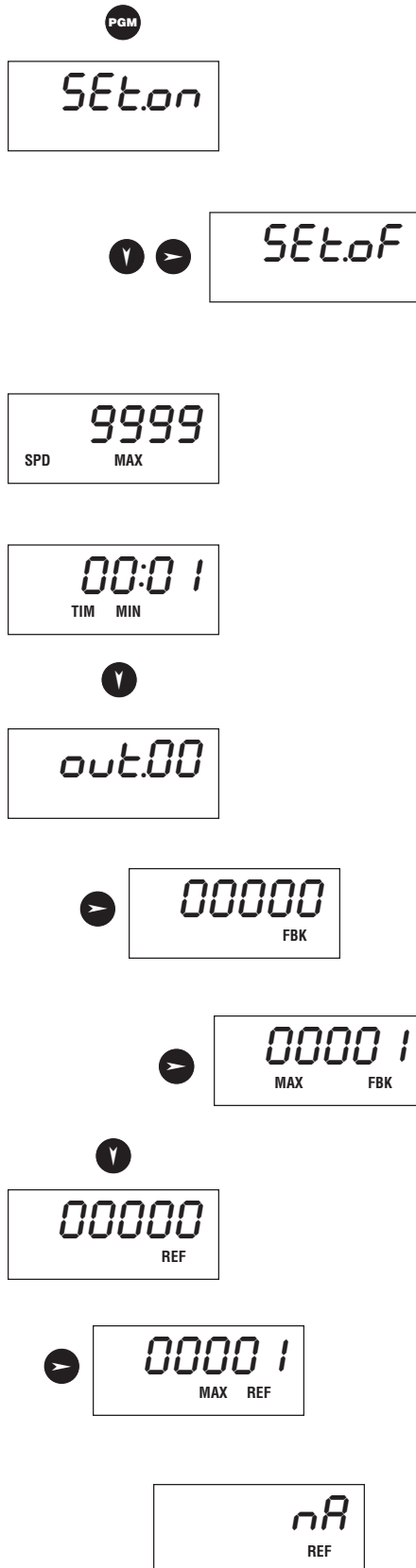

The Program displays are accessible only when the AUT and JOG inputs are opened, the unit has stopped and switch #3 is left (PGM ENA).

From any Operating or Setup display, press the PGM key to access the Program displays.

6. Setup

The Setup allows display of PID Errors and adjustment of the PID Gains

Press the Right cursor to alternately turn Setup "Off" and "On".

7. Maximum Speed / Minimum Process Time

In the Leader Speed and Follower modes, the Maximum Speed value calibrates the speed displays to engineering units. Change the decimal point position by pressing the + or – keys when no digit is selected (brighter). Then, use the Right cursor, + and – keys to enter the value that corresponds to full scale (Maximum Analog Output and Maximum Feedback frequency).

In the Leader Process Time mode, the Minimum Process Time value calibrates the process time displays. Use the Right cursor, + and – keys to enter the time, in minutes and seconds, that corresponds to full scale (Maximum Analog Output and Maximum Feedback frequency).

8. Percent Output / Feedback / Maximum Feedback

Use the Percent Output to test and calibrate the Drive Output, motor connection and feedback device. The Percent Output can be set from 0 to 99% with the Right cursor, + and – keys.

Access the Feedback display by pressing the Right cursor after setting a Percent Output value. The actual feedback frequency, in Hz will be displayed.

Set the Maximum Feedback frequency by pressing the Right cursor and using the + and – keys to change the display value. The Maximum Feedback frequency should correspond to full scale (maximum Analog Output).

Note: The most accurate method of programming values for 8. & 9. is to set the analog output to 50% then double the speed and feedback values achieved at this output level. This method minimizes errors due to non-linearity in the drive that may be present when near full output.

9. Reference / Maximum Reference

The Reference display monitors and shows the frequency, in Hz, of the Reference Input used for Follower operation.

Set the Maximum Reference frequency by pressing the Right cursor and using the + and – keys to change the display value. The Maximum Reference frequency should correspond to full scale (maximum Analog Output).

In Leader Speed or Process Time modes, this display changes to nA to indicate that the Reference Input function is not applicable.



10. Jog Speed

The Jog Speed is used during Manual operation (AUT input not active). Jogging will perform an open loop movement which continues as long as the RST-JOG input is active. The Jog Speed is in the same engineering units and displayed with the same decimal point position as the Maximum Speed.

Enter a Jog Speed by pressing the Right cursor and using the + and - keys to change the value.



11. Accel / Decel Ramp Rate

The Ramp Rate determines how fast the control responds to changes to Speed or Ratio Setpoint values, and during starts and stops. The Ramp Rate is in Speed or Ratio units per second, or minutes and seconds per second for Leader Time operation.

For Process Time operation, the ramp time is the period of time to go from a stop to full speed, or minimum process time, and vice versa.



12. Minimum Setpoint

The Minimum Setpoint value limits the value of changes that can be made to the Speed, Ratio or Process Time Setpoints by the operator. The Setpoint value cannot be changed to a number lower than the Minimum Setpoint. Enter a Minimum Setpoint by pressing the Right cursor and using the + and - keys to change the value.

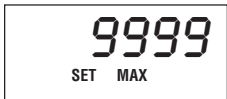

13. Maximum Setpoint

The Maximum Setpoint value limits the value of changes that can be made to the Speed, Ratio or Process Time Setpoints by the operator. The Setpoint value cannot be changed to a number higher than the Maximum Setpoint. Enter a Maximum Setpoint by pressing the Right cursor and using the + and - keys to change the value.



14. Setpoint Adjustment Method

Operator changes to the Speed, Ratio or Process Time Setpoint can be enabled, disabled or restricted. Use the Right cursor to alternately select Setpoint changes only incrementally (with the + and - keys), digit-by-digit (using the Right cursor and + or - keys), both incrementally and digit-by-digit, or to not allow any changes to the Setpoint.

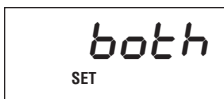



15. Minimum Alarm / Minimum Percent Alarm

The Minimum Alarm is set in the same units as the Speed, Process Time or Ratio Setpoints, and turns the LO ALM output on whenever the Actual Speed, Process Time or Ratio falls below its value.

The Minimum Percent Alarm turns the LO ALM output on whenever the Actual Speed, Process Time or Ratio falls below a percentage of the setpoint value. This alarm can be disabled by setting its value to zero.

16. Maximum Alarm / Maximum Percent Alarm

The Maximum Alarm is set in the same units as the Speed, Process Time or Ratio Setpoints, and turns the HI ALM output on whenever the Actual Speed, Process Time or Ratio goes above its value.

The Maximum Percent Alarm turns the HI ALM output on whenever the Actual Speed, Process Time or Ratio goes above a percentage of the setpoint value. This alarm can be disabled by setting its value to zero.

DIAGNOSTIC DISPLAYS

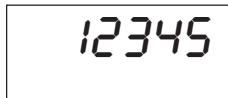
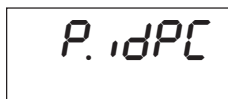
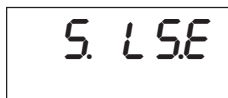
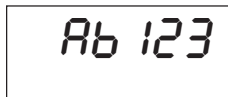

17. Inputs Display

The status of the two signal inputs and three control inputs are shown in this display. These prompts are displayed when the respective inputs are high: **A** for SIGA (FBK); **b** for SIGB (REF). These prompts are displayed when the respective inputs are low: **l** for AUT; **2** for RST-JOG; and **3** for RMP HLD.

18. Switches Display

The status of the two Operation Mode and the Program Enable/Disable switches are shown in this display: **LS** for Leader Speed mode; **LT** for Leader Time mode; and **Fr** for Follower Ratio mode. **E** is displayed when switch #3 is left (PGM ENA); **d** when switch #3 is right (PGM DIS).

19. Output Test

The two alarm outputs can be tested using this display. Press the Right cursor to select (brighten) output #1 (LO ALM). Turn the output on by pressing the + key, and off by pressing the - key. Press the Right cursor to select and control output #2 (HI ALM).

20. Keyswitch Display

The status of the front panel keyswitches are shown in this display. A prompt is displayed when the respective keys are pressed: **+** for the + key; **-** for the - key; **P** for the PGM key; and **⏏** for the RST key.

21. Digits Display



This constant pattern is displayed to verify that all digits are working and that no digits are tied together.

22. Segments Display

All digit segments and annunciators are displayed.

ERROR CODES

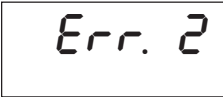
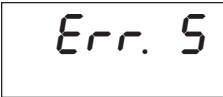
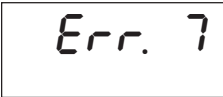
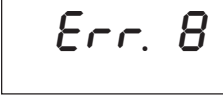
These Error Codes are detected and displayed when conditions prevent normal operation. These conditions will automatically cause a stop. Error Code displays can be cleared by pressing the RST key. To restart, the AUT input must be removed (open) and reapplied (closed).

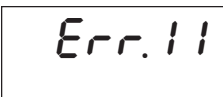
	EXPLANATION	CORRECTIVE ACTION
	Low AC Line Voltage <ol style="list-style-type: none">1. Brownout.2. Heavy loads on AC power.	<ol style="list-style-type: none">1. Restart after brownout following the steps, above.2. Isolate power using separate branch circuit or install isolation/constant voltage transformer.
	Nonvolatile Memory Failure <ol style="list-style-type: none">1. Data corrupted by transient noise.2. Damaged component.	<ol style="list-style-type: none">1. Check programming data; reprogram if necessary.2. Return for repair.
	Reference Frequency Too High <ol style="list-style-type: none">1. Excessive input resolution or frequency.2. Electrical noise.	<ol style="list-style-type: none">1. Limit full scale reference input to 20kHz.2. Install shielded cable; tie shield to Earth Ground.
	Feedback Frequency Too High <ol style="list-style-type: none">1. Excessive input resolution or frequency.2. Electrical noise.	<ol style="list-style-type: none">1. Limit full scale feedback input to 20kHz.2. Install shielded cable; tie shield to Earth Ground.
	Invalid Hardware <ol style="list-style-type: none">1. Switches #1 and #2 in right position.	<ol style="list-style-type: none">1. Check and change switch settings.
	Loss of Feedback <ol style="list-style-type: none">1. Feedback signal missing.	<ol style="list-style-type: none">1. Check feedback signal wiring.2. Run open loop (RST-JOG to COM).

1. Switch Settings

Set switches #1 and #2 to the left for Leader Speed operation. Initially, set switch #3 left to enable access to the Program displays; program access can be disabled after setup. Set switches #4, #6 and #8 to match the feedback sensor output and power requirements.

2. Inputs and Outputs

Connect AC power, the feedback sensor and an Auto/Manual switch as shown. Other inputs and alarm outputs may be connected, but are not required. Apply power to the unit. Set the external switch to Manual position and enter the Program displays by pressing the PGM key. Use the Diagnostic displays to check the operation of the switch inputs, alarm outputs and feedback sensor device.

3. Drive Connection

Turn power off and connect the analog output to the drive. Use the internal reference wiring if the drive is compatible with a 0-10V command; use the drive's reference (external reference wiring) for drives that require a range other than 0-10V.

Refer to the drive's installation instructions and adjust the settings (if available) as follows: Minimum Speed to minimum; Maximum Speed to maximum; Ramp or Accel/Decel Rate(s) to fastest; IR Compensation and Torque Limit as recommended. Apply power to the control and then to the drive and verify that the motor is not being commanded to move.

Test the drive connection by using the Percent Output display to command the drive, and verify that the motor speed matches the Percent Output value. If the motor response is not satisfactory, check the drive settings above.

4. Feedback Device

Use the Percent Output to command the motor, and observe the feedback device frequency. The frequency should be approximately equal to $(\text{shaft speed in RPM} \div 60) \times \text{feedback device PPR}$. If it is not, adjust the drive's gain (sensitivity) setting or change the drive wiring from the internal reference to the drive's reference. Check the frequency near full speed to ensure that the maximum input of 20 kHz will not be exceeded.

Set the Maximum Feedback frequency value using the full speed value displayed or the calculated value, above.

5. Speed Units Calibration

Speed displays can be calibrated to any engineering units required (RPM, feet/min, gal/hr, etc.). Set the Maximum Speed to a value that corresponds to full scale speed (100% output) and Maximum Feedback frequency. For example, if 0-10V represents 0 to 1800 RPM, then enter 1800 for Maximum Speed to calibrate the speed displays to read RPM. Alternately, if the range is 0 to 720.0 feet/min, set the Maximum Speed and decimal point position to indicate 720.0 .

Enter a Jog Speed setpoint, if desired.

Set the Accel/Decel Ramp value to control starting and stopping. To determine the ramp time, divide the Speed or Jog Speed setpoint by the Ramp. For example, if the Speed Setpoint is 500.0 feet/min and the Ramp is 100.0, starting or stopping will take $(500.0 \div 100.0)$, or 5 seconds. Or, a Speed setpoint change from 500.0 to 550.0 will take $(50.0 \div 100.0)$ or 0.5 seconds.

Minimum and Maximum Setpoints and Speed Alarms may be likewise set.

6. Startup

Exit the Program displays by pressing the PGM key. Enter a value for a Speed Setpoint. Set the external switch to the Auto position, and observe the motor accelerate to a constant speed close to the setpoint. Also verify that the Actual Speed display indicates the correct motor speed.

Operation of the RST-JOG and RPM HLD inputs, and alarm outputs should be checked at this time (if used).

PROCESS TIME

Set switch #1 left and #2 right for Leader Time operation. Complete setup according to steps 1 through 5 for Speed Control.

1. Process Time Calibration

The Process Time is displayed in minutes and seconds, and is inversely proportional to speed. Set the Minimum Time value to correspond to full speed (100% output) and Maximum Feedback frequency. In a broiler application, for example, 10V produces a conveyor speed of 3 inches per second. If the broiler cooking area is 6 feet, or 72 inches, long, the equivalent cooking time is $(72 \div 3)$ 24 seconds. If the motor drives the conveyor at 25% of full speed, then the cooking time becomes four times longer, or 1:36 (96 seconds). For this example, enter 0:24 for Minimum Time to calibrate the Process Time displays.

Minimum and Maximum Setpoints and Process Time Alarms may be likewise set.

2. Ramp Rate

Set the Accel/Decel Ramp value to control starting and stopping. The ramp time is the period of time to go from a stop to full speed, or minimum process time, and vice versa.

For the previous example, 0:24 was the Minimum Process Time that represented full speed. For a 2:00 time to go from stopped to the Minimum Process Time, set the Accel/Decel Rate to 2:00. If the Process Time Setpoint was changed to 1:36 (25% of full scale speed), the start/stop time would be 25% of 2:00, or 0:30.

3. Startup

Exit the Program displays by pressing the PGM key. Enter a value for a Process Time Setpoint. Set the external switch to the Auto position, and observe the motor accelerate to a constant speed. Verify that the Actual Process Time display indicates the correct time.

Operation of the RST-JOG and RPM HLD inputs, and alarm outputs should be checked at this time (if used).

SPEED FOLLOWER

Set switch #1 right and #2 left for Speed Follower operation. Complete setup according to steps 1 through 5 for Speed Control.

1. Reference Device

Connect the Reference sensor. Run the process and use the Reference display to monitor the Reference input frequency. The frequency should be approximately equal to $(\text{shaft speed} \div 60) \times \text{Reference device PPR}$. Check that the Reference will not generate a frequency above the maximum 20 kHz allowed. Set the Maximum Reference frequency value to the full scale input of the Reference sensor or the calculated value.

2. Startup

Set the Accel/Decel Ramp rate to control starting and stopping of the follower and changes to the Ratio Setpoint. For the fastest response, set the rate to 9.999. Exit the Program displays by pressing the PGM key. Enter a value for a Ratio Setpoint, for example, 1.000 if the follower is to match the speed of the leader. Set the external switch to the Auto position. Start the process to be followed and observe that the Speed Follower starts, runs and stops with the process. Verify that the Actual Speed display indicates the correct follower speed.

Operation of the RST-JOG and RPM HLD inputs, and alarm outputs should be checked at this time (if used).

APPLICATION HINTS

1. Additional Scaling Capabilities

Scaling can be used to calibrate the 10V analog output to a drive input range of 3V, in the case where the 3V drive reference is unavailable. To limit the analog output, increase the value of the Maximum Speed proportionally.

For example, a Maximum Speed value of 1800 RPM corresponds to the full scale 10V output. A Speed Setpoint of 600 RPM produces $(600\text{RPM} \div 1800\text{RPM} \times 10\text{V})$, or 3.3V output. Change the Maximum Speed to 5400 RPM. At 600 RPM, the output is only $(600\text{RPM} \div 5400\text{RPM} \times 10\text{V})$, or 1.1V output.

Complete the setup according to one of the basic operating modes on the previous pages. PID tuning uses speed changes to observe the system and make adjustments to improve its performance. Leader Speed mode is the most convenient operating mode to perform PID tuning, and is used in method below.

Start with the Proportional, Integral and Derivative Gains all set to zero, and the Accel/Decel Ramp Rate to the highest value allowable for the system. Enter a setpoint and enable the system to run at 80 to 100% of full speed. Perform the adjustments under Drive Connection, if the system does not appear to run at the correct speed, or takes excessive time to ramp up to speed.

1. Proportional Error / Gain

Proportional Error is similar to the stretching of a spring. The correction applied from Proportional control, the Proportional Error x Proportional Gain, acts like the force exerted by a spring when it is stretched and is proportional to the amount of the stretch. For speed control, the larger the Proportional Error (or difference between the Actual Speed and the Speed Setpoint, either overspeed or under speed), the larger the correction that is applied.

To adjust the Proportional Gain, repeatedly change the Speed Setpoint to run the system fast (80 to 100% of full scale) and slow (10 to 20% of full scale). Use the Actual Speed and/or Proportional Error displays to watch for overshoot of the Speed Setpoint. Increase the Proportional Gain by 10% after each change, until overshoot of the Speed Setpoint occurs. Then, decrease the Proportional Gain by 10% for added margin.

2. Integral Error / Gain

A motor and drive is an integrator of command voltage. That is, if the command is not zero, the motor and drive integrate the command, over time, which results in a change of position. Even if the command is returned to zero, the integral, or position, does not return to zero automatically.

In a speed control, the Integral Error accumulates Proportional Error over time, and so corrects the speed control for long term drift. While the Proportional Error would settle at some value, the Integral Error tends toward zero.

After the Proportional Gain has been adjusted, increase the Integral Gain by 10%. Run the system fast and check that the Actual Speed eventually reaches the Speed Setpoint. Increase the Integral Gain by 10% and run the system both fast and slow. The times for the Actual Speed to reach the Speed Setpoint should get lower. Continue to increase the Integral Gain until oscillation begins at one of the speeds. Then, decrease the Integral Gain by 10% for added margin.

3. Derivative Error / Gain

Derivative control acts like shock absorbers on a car. Regardless of how heavy the car is loaded (which is handled by the springs), they "dampen" movement and resist rapid disturbances. Derivative control in a speed application works to stabilize the system and resist large, rapid changes to speed.

After the Proportional and Integral Gains have been adjusted, again change the Setpoint to run the system fast and slow. Increase the Derivative Gain by 10% each time, until the system overshoots the Speed Setpoint, or the accel/decels ramp time begins to increase noticeably. Then, decrease the Derivative Gain by 10% for added margin.

GENERAL

ORDERING INFORMATION

Model	Description	Model	Description
MSJR4U00	Digital Speed Control	MDJR1U00	1/8 DIN Digital Drive
MSJR5U00	Digital Speed Control with Analog Trim Input	MDJR2U00	1/4 DIN Digital Drive

WARRANTY

Standard products manufactured by the Company are warranted to be free from defects in workmanship and material for a period of one year from the date of shipment, and products which are defective in workmanship or material will be repaired or replaced, at the option of the Company, at no charge to the Buyer. Final determination as to whether a product is actually defective rests with the Company. The obligation of the Company hereunder shall be limited solely to repair and replacement of products that fall within the foregoing limitations, and shall be conditioned upon receipt by the Company of written notice of any alleged defects or deficiency promptly after discovery within the warranty period, and in the case of components or units purchased by the Company, the obligation of the Company shall not exceed the settlement that the Company is able to obtain from the supplier thereof. No products shall be returned to the Company

without its prior consent. Products which the Company consents to have returned shall be shipped F.O.B. the Company's factory. The Company cannot assume responsibility or accept invoices for unauthorized repairs to its components, even though defective. The life of the products of the Company depends, to a large extent, upon the type of usage thereof, and THE COMPANY MAKES NO WARRANTY AS TO FITNESS OF ITS PRODUCTS FOR SPECIFIC APPLICATIONS BY THE BUYER NOR AS TO PERIOD OF SERVICE UNLESS THE COMPANY SPECIFICALLY AGREES OTHERWISE IN WRITING AFTER THE PROPOSED USAGE HAS BEEN MADE KNOWN TO IT.

THE FOREGOING WARRANTY IS EXCLUSIVE AND IN LIEU OF ALL OTHER WARRANTIES EXPRESSED OR IMPLIED, INCLUDING, BUT NOT LIMITED TO ANY WARRANTY OF MERCHANTABILITY OR OF FITNESS FOR A PARTICULAR PURPOSE.

SERVICE

If this product requires service, call the number below for an Return Material Authorization (RMA) number, pack it in a sturdy carton with the RMA number clearly marked on the outside, and ship prepaid to: Service Department at the address below.

Please Include:

1. A description of problem
2. The name of responsible person
3. Your purchase order number
4. Your return shipping instructions